



# OPERATING GUIDE

## INSIDE THIS GUIDE:

FBX-901 Controls	2
Applications	3
Operating Instructions	4,5
Troubleshooting Tips	6
Product Specifications	6
Block Diagram	7
FCC Statement	7
Cautions	8
Warranty	8



**CONGRATULATIONS!** You now have the state-of-the-art in feedback control. Your Sabine FBX-901 Feedback Exterminator gives you automatic real-time feedback control and increases the clarity and volume of your system.

The FBX-901 incorporates the latest in design and digital signal processing technology. It automatically senses feedback in a sound system and determines its pitch. It then places one of nine micro-filters on the resonating frequency and eliminates the feedback in typically less than one second (typical).

Virtually every sound system will be improved with the FBX. Auditoriums and churches of all sizes will benefit from automatic, real-time feedback control. Hotels and conference centers around the world can offer meeting rooms with sound systems that won't howl during programs.

The simple beauty of the FBX is its ability to quickly and effectively eliminate feedback with narrower filters than ever before possible. With the FBX, your system will finally be loud enough and sound natural and transparent, and everyone in the audience will understand each word.

### SPECIAL FEATURES OF THE FBX-901

- The FBX-901 has an **improved algorithm** that allows it to better distinguish the difference between feedback and music, greatly reducing the chance for error.
- It has **improved shielding** that prevents interference with broad band wireless microphone systems.
- A new **LOCK FIXED** button "freezes" the fixed filters created during set-up. The filters still eliminate feedback, but they will not get any deeper than the original setting.
- You can **limit the total number of active filters** for each application by following a simple procedure during set-up.
- The FBX-901 has **switchable filter widths** - from 1/10 octave for musical programs to 1/5 octave for speech applications.
- It now includes a **selectable noise gate**, useful in systems with a number of open microphones.

FBX and FBX Feedback Exterminator are registered trademarks of Sabine, Inc., and are the brand names of its line of automatic feedback controllers. Covered by U.S. Patent No. 5,245,665, Australian Patent No. 653,736, and Canadian Patent No. 2,066,624-2. Other patents pending.

**SABINE™**  
ADAPTIVE AUDIO

# FBX-901 CONTROLS

## FRONT PANEL

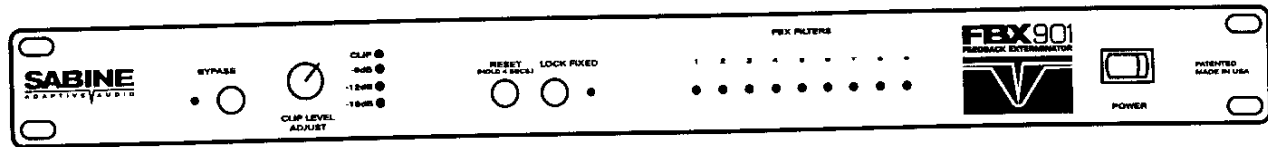

### ACTIVE/BYPASS

Hardwire bypass mode takes the unit out of the signal path so it will have no effect on the program. In active mode, the unit controls feedback automatically. The LED indicates whether the unit is in active or bypass mode, lighting green in active mode and red in bypass mode.

### RESET

Press for 4 seconds, or until the lights stop flashing, to reset all filters.

### POWER SWITCH

The ON/OFF switch is a two-position rocker-type switch. The LEDs corresponding to all active filters will blink on power-up.

### FILTER STAGE ACTIVITY

When one of the unit's filters is activated, the corresponding LED lights. A blinking LED indicates the filter that was most recently updated or activated.

### CLIP LEVEL ADJUST

Adjust the CLIP LEVEL so that the CLIP LED blinks intermittently. Higher levels will cause distortion and lower levels will cause an increase in sound system noise level. The FBX combines the input and output levels into one control so there is no net gain or loss of signal through the unit regardless of where the CLIP LEVEL is set.

### LOCK FIXED FILTERS

When the "LOCK FIXED" button is pressed, its LED will light to indicate that the FBX is in "LOCK FIXED" mode. "LOCK FIXED" mode can be activated at any time after system set-up and will stay on until the button is pressed again and the LED turns off.

You can also use the "LOCK FIXED" button to limit the total number of active filters. You must reset the unit the next time you wish to use all nine filters.

## BACK PANEL

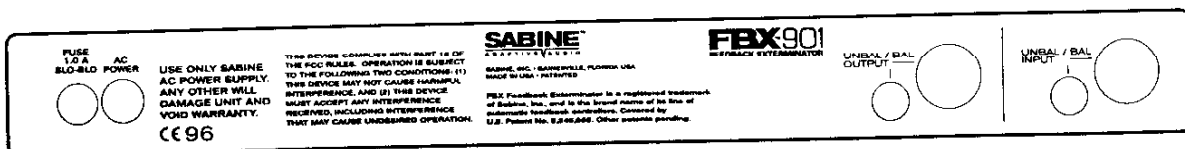

### A/C ADAPTOR

The FBX external power supply is included with the unit. Use of any other power supply may cause permanent damage to the unit and **WILL VOID THE WARRANTY.**

### INPUT AND OUTPUT

1/4" TRS and XLR balanced and unbalanced.

# APPLICATIONS

## FBX SET-UP FOR MONITORS:

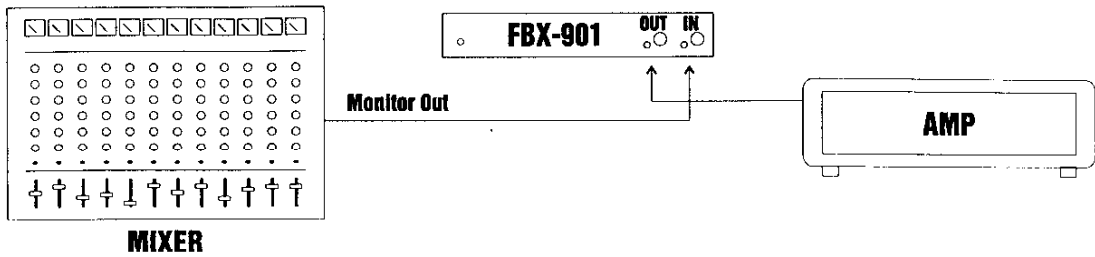

## FBX SET-UP FOR ENTIRE MIX:

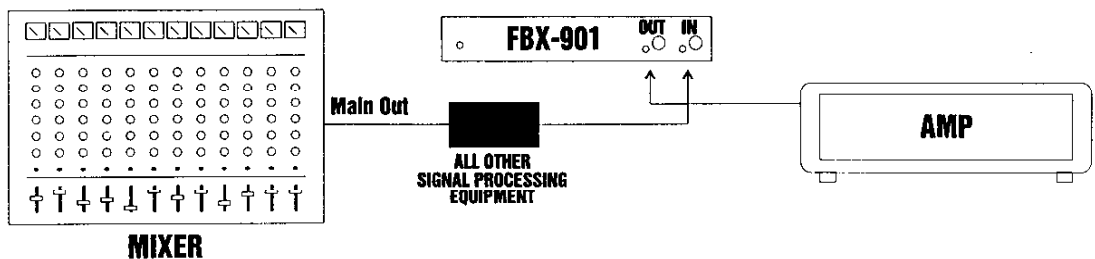

## FBX SET-UP FOR INSERT POINTS:

### MIXER Input Channel

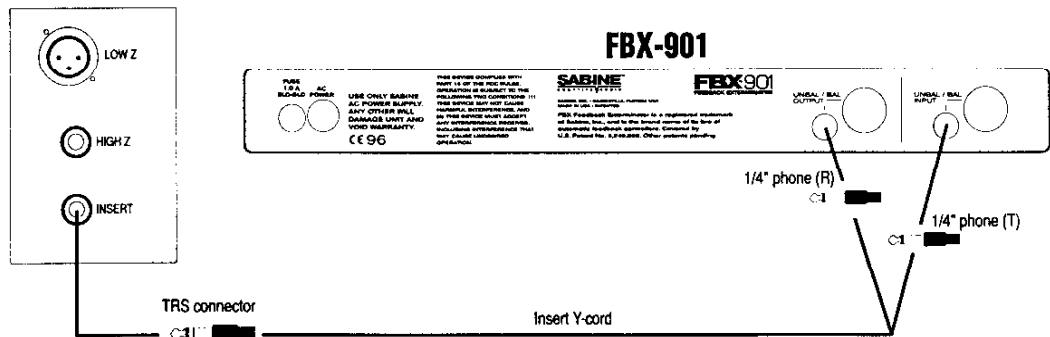

### MIXER Input Channel

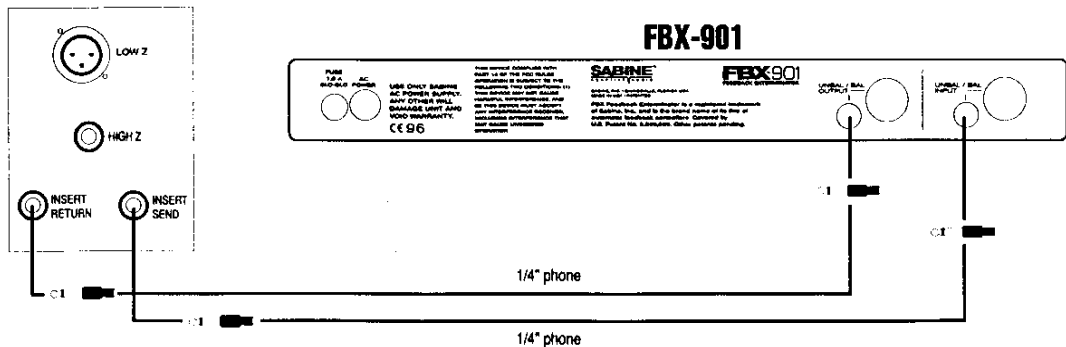

# OPERATING INSTRUCTIONS

## BEFORE YOU BEGIN

The FBX automatic feedback controller will improve any sound reinforcement system even if it is used incorrectly. By following these simple suggestions, you will be assured of the most benefit from your FBX and sound system. The instructions presume that you are familiar with the fundamentals of sound reinforcement.

### Where to place the FBX in your sound system:

Place the FBX anywhere in the sound system that a graphic equalizer might be used to control feedback. The most common place is between the output of the mixer and the input of a power amp. In this position, the FBX can sense and eliminate feedback occurring in any channel of the mixer. The FBX can also be used on a mixer insert point.

### A note about graphic equalizers:

The FBX is designed to replace the graphic equalizer's function for eliminating feedback. In many applications, such as churches, auditoriums or small acoustic ensembles, the mixing board provides all the tonal control that is necessary. The FBX can replace the graphic EQ altogether in some applications.

If an equalizer is desired, place the FBX after the EQ in the signal path. Use the EQ's controls to shape the tonal response of the sound system but DO NOT NOTCH FOR FEEDBACK.

### Understanding fixed and dynamic filters:

Before operating the FBX, you need to understand the two types of FBX filters: FIXED and DYNAMIC. FIXED FILTERS retain their frequency center-points until the unit is reset by the user. The system's gain before feedback is limited by the number of FIXED FILTERS; i.e., increasing the number of FIXED FILTERS increases the system's gain before feedback. The FBX's DYNAMIC FILTERS control intermittent feedback that comes and goes throughout the program. They are continually reset automatically to different frequencies as new feedback occurs during the program. **For most applications, the optimal setting is six FIXED and three DYNAMIC FILTERS. This is the factory default.**

## HOW TO OPERATE THE FBX-901

Follow these steps to obtain the maximum gain before feedback without changing the tonal quality of your program.

1. Place the speakers and microphones in the positions where they will be used during the program. Avoid placing microphones directly in front of speakers.
2. Place the FBX in BYPASS MODE. (The BYPASS LED will light red to indicate it is in BYPASS mode.)
3. Set the master volumes to their lowest positions. Turn on the mixer, then the FBX, then any other accessories and finally the power amp.
4. If you are using a graphic EQ, adjust only for the desired tonal qualities, but DO NOT NOTCH FOR FEEDBACK.
5. Adjust the level for each mixer channel.
6. Set the sound system's master volume to minimum.

7. Turn the FBX CLIP LEVEL ADJUST clockwise to the two o'clock position.
8. Press RESET for 4 seconds (or until the LEDs stop flashing) to clear out filters set previously.
9. Place the FBX in ACTIVE mode. (The BYPASS LED will light green to indicate it is in ACTIVE mode.)
10. **Slowly** raise the sound system's master volume for the channel being set until feedback occurs. The FBX should quickly remove the feedback. The first FILTER LED will then blink to indicate a filter has been set.
11. Repeat the procedure described in line 10 until all of the FIXED FILTERS and one of the DYNAMIC FILTERS are set.
12. Now lower the master volume slightly so that the system is not on the verge of another feedback point. This is the maximum volume level that the FBX will be able to provide. Higher levels will cause uncontrollable feedback.
13. Finally, during sound check, adjust the CLIP LEVEL ADJUST so that the red CLIP LED blinks intermittently, as you would adjust the recording level of a tape recorder. The unit will clip and distort the program if the CLIP LEVEL ADJUST is set too high. If it is set too low, the signal-to-noise ratio will degrade and the system may hiss. The best adjustment occurs when the clip levels of the FBX and the final power amplifier are matched. This occurs when the clip level indicators on the FBX and the final amplifier blink at the same time. Don't be surprised if the CLIP LEVEL ADJUST appears low after adjustment during sound check. In some cases, the proper CLIP LEVEL ADJUST setting could be as low as the nine o'clock position. This is normal and will not affect the performance of the FBX or your sound system.

**•Please note:** If you are using a mixer with unbalanced 1/4" outputs, you must use standard unbalanced cables and connectors when connecting it to the FBX. Similarly, if your mixer is wired for balanced 1/4" (Ring/Tip/Sleeve) outputs, you must use that type of connector. If you do not follow this procedure, you may experience a loss of gain when using the FBX.

The FBX is designed for balanced output. If either side of the balanced output is grounded at any point, clipping or a 6 dB loss in dynamic range may occur at high signal levels (+21 dB peaks or higher).

## HOW TO USE THE SPECIAL FEATURES

### Changing the number of fixed vs. dynamic filters:

The filters can be easily reconfigured from the factory default (six fixed and three dynamic) setting. For example, the following procedure will set five filters fixed and four filters dynamic:

1. Place the unit in BYPASS mode.
2. Turn the unit off.
3. While depressing the RESET button, turn the unit on.
4. Release the RESET button. The FILTER INDICATOR LEDs will now light in sequence.
5. When the fifth LED is lit, press the RESET button.
6. Notice that the five LEDs on the left flash three times to verify that they are now the fixed filters.

The fixed filters flash three times when the 901 is powered up.

### Using the "LOCK FIXED" feature:

In certain situations the FBX may mistake music for feedback and drive the fixed filters deeper than necessary. Typical examples might be in a church with a pipe organ or during a performance with a great deal of intentional sustained electric guitar feedback. You may prevent the fixed filters from deepening beyond their preset depth by pressing the "LOCK FIXED" button on the front panel. The "LOCK FIXED" LED will light to indicate that the FBX is in "LOCK FIXED" mode. The fixed filters will stay locked until you press the "LOCK FIXED" button again. The dynamic filters are not affected.

### Limiting the total number of active filters:

You may choose to limit the total number of active filters for each application by using the "LOCK FIXED" button. For example, if you wish to use only three fixed and three dynamic filters, set the FBX so that there are six fixed and three dynamic filters (factory default configuration). Then during the set-up procedure, simply press the "LOCK FIXED" button after setting the first three fixed filters. The remaining three fixed filters will be locked in their zero position. **IMPORTANT NOTE:** You must reset the unit the next time you wish to use the locked filters. (You cannot unlock zero position filters.)

### Enabling the noise gate:

One outstanding feature of your FBX-901 is a user-selectable noise gate. It acts as an automatic switch that opens a microphone only when someone is speaking directly into the mic. A noise gate is especially useful in systems that have a number of open microphones, such as courtrooms, conference rooms, or distance learning sites. Gating microphones greatly reduces the number of possible feedback points in the room and allows for more system gain.

The level that opens and closes the noise gate is called the threshold. If the level coming into the gate is greater than the threshold, the noise gate opens, and the mic is turned on. If it is less than the threshold, the noise gate closes, and the mic is turned off.

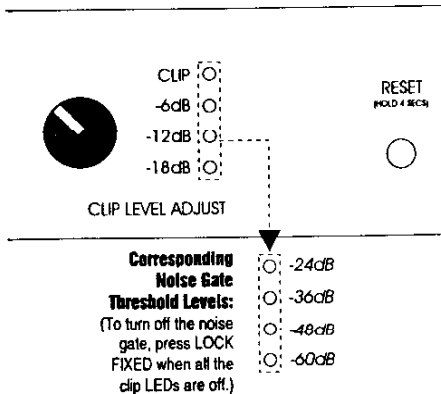

You can adjust your 901 to four different threshold levels or turn it off. (Factory default is off.) To enable the noise gate and select the threshold, power down the 901. Hold in the LOCK FIXED button, and power up the 901. When you let go of the button, the clip level LEDs will light in sequence. Select the threshold level by

pressing the LOCK FIXED button again when the clip LED lights at the corresponding level. (See illustration above.) To disable the noise gate, press the LOCK FIXED button when no clip LEDs are lit.

When the noise gate is enabled, the clip light corresponding to the selected threshold level flashes on power-up. If no clip lights flash on power-up, the noise gate is not enabled. **NOTE:** The 901's noise gate will not become active until after

you've set all fixed filters and one dynamic filter (if the 901 is configured for any). The noise gate also becomes active when you press the LOCK FIXED button.

### Selecting filter width:

If the FBX-901 is to be used for a music application, 1/10-octave filters are most effective. However, in spoken word applications, such as lectures or teleconferencing, the wider 1/5-octave filters are recommended. To select the filter width, first power down and unplug the unit; then remove the 901's top panel. Factory default is 1/10-octave, with the jumper in place as shown below (between pins 4 and 5 of J1). Remove the jumper to activate the 1/5-octave filters. (To store the jumper, turn it so it lies on only one pin.) Reassemble the unit, and power it up to implement the change.

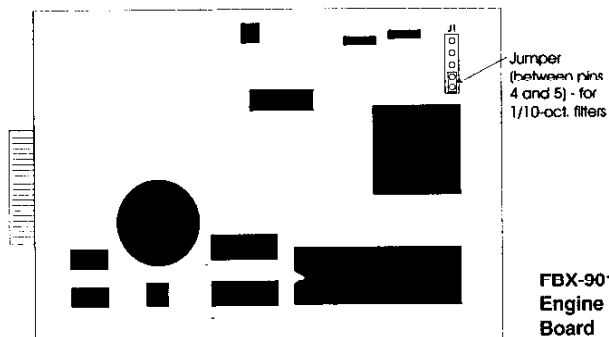

## IMPORTANT OPERATING CONSIDERATIONS

### Memory:

The FBX stores the positions and depths of the filters in nonvolatile internal memory when the unit is turned off or during a power failure. The unit will return all filters to their previous frequencies and depths when it is turned back on.

### Bypass mode:

The FBX has a true power-off bypass. The signal is unaffected in BYPASS MODE even if the unit is turned off. Please note that if a combination of BALANCED and UNBALANCED inputs and outputs is used, the signal may be disconnected in BYPASS MODE.

### Resetting the filters:

You must reset the FBX if the microphones or speakers are moved significantly. To reset the unit, place the PA system's master volume to minimum and then press the reset button for four seconds until the FILTER LEDs stop flashing. Then follow the system initialization procedure explained previously.

### Power down:

Place the unit in BYPASS MODE before powering down or powering up the unit. This reduces the chance of a "pop" being heard through the system.

### Optional transformers:

Optional isolation transformers are available. The FBX-901 is available with Jensen balanced line transformers that will provide up to 24dBV. (Higher levels can be accommodated on special request. Contact Sabine for more information.)

## TROUBLESHOOTING TIPS

Q. Can I place the **FBX** in the mixer's EQ loop?

A. Yes.

Q. Can I place the unit in the mixer effects loop?

A. Avoid this configuration if possible. You can configure the system this way only if each effects send of each mixer channel is set so that all of the signal is routed completely through the effects loop. You cannot mix dry signal with effects signal and still control feedback.

Q. The LEDs on the CLIP LEVEL ADJUST do not light. The unit will not catch feedback. Why?

A. The unit is not in the signal path. Check the connections. Be sure that the program is interrupted when the input is disconnected from the back of the unit.

Q. Can I mix balanced and unbalanced inputs and outputs?

A. Yes. An unbalanced input and balanced output is acceptable. However, a balanced input and unbalanced output may result in a 6 dB loss of dynamic range, and the bypass function may not operate correctly.

Q. Why does one of the FILTER ACTIVITY LEDs blink?

A. The last filter to be automatically updated blinks. During normal operation, the blinking will move from filter to filter as they are reset. This gives the user a visual confirmation that the unit is responding to new feedback and is functioning properly.

Q. Sometimes during the initial set-up, the first filter LED will blink before any feedback has been introduced into the system. Why?

A. The **FBX** will set a filter if the system has a hum. Check for bad grounds. Turn the CLIP LEVEL all the way clockwise, reset the filters, and try again.

Q. Why does the **FBX** cause a noticeable hum?

A. It hums if the main power voltage drops significantly below 10% of the specified voltage. Check the A/C power mains.

Q. Why does my system sound thin and muffled?

A. Place the **FBX** in BYPASS MODE. If the system still sounds thin, your problem is probably with improper use of a graphic EQ. If the problem is really the **FBX**, reinitialize the system. Also, be sure that the unit's CLIP LEVEL is properly adjusted.

Q. Can I wire two outputs to the 901? Are they in parallel?

A. The 901's outputs are in parallel, and you may use both of the 901's outputs to drive other equipment. Do not patch in two inputs to the 901; this may cause a short in the system.

## FBX-901 ENGINEERING SPECIFICATIONS

### FILTERS

Nine independent digital notch filters controlled automatically from 51Hz to 17,000Hz

**Filter width:** 1/10 octave, typical, or 1/5-octave selectable

**Filter depth:** DSP controlled, variable to -50dB

**Resolution:** 1/20 octave or better

**Time required to find and eliminate feedback:** 0.4 seconds, typical @ 1KHz

**Total number of combined filters active:** User selectable, from 1 to 9

**Number of Dynamic vs. Fixed filters:** User selectable

**Last configuration stored in memory**

### INPUT/OUTPUT\*

**Input Impedance:** Unbalanced 10K Ohms; Balanced >10K Ohms, PIN 2 high

**Output Impedance:** Balanced or unbalanced 10 Ohms nominal, PIN 2 high; Maximum load 600 Ohms

**Bypass:** True Power Off Bypass

Balanced to Balanced; Unbalanced to Unbalanced

**Input/Output Maximum Signal Levels:** Unbalanced +20dBV peak; Balanced +26dBV peak

**Headroom:** Unbalanced +16dB @ +4dBV nominal input; Balanced +22dB @ 4dBV nominal input

**I/O Connectors:** XLR-3 and 1/4" TRS

### PERFORMANCE\*\*

**Frequency Response:** < ±0.5dB, 20Hz to 17,000Hz

**Signal to Noise Ratio:** >86dB typical (Balanced)

**Total Harmonic Distortion:** <0.015% @ 1KHz @ +22dBV

**Dynamic Range:** >92dB

**Input to Output Gain Variation:** ± 1dB

### POWER SUPPLY\*\*\*

18-24VAC @ 400 mA

### MEMORY BATTERY LIFE

10 years, typical

### DIMENSIONS

1-U rack mount; 19 x 1.75 x 5.5 in. nominal; 48.3 x 4.5 x 13.9 cm nominal

### WEIGHT

6.0 lbs. (2.7 kg) nominal

### OPTIONS

Input/output transformer option

\* (Note: Inputs may be balanced or unbalanced. For maximum output capability, outputs must be balanced (XLR or TRS). If either side of an output is grounded, the peak output and dynamic range will be reduced by 6 dB. If a grounded output cannot be avoided, use a balanced line transformer or the output transformer option.)

\*\* Tests performed using an Audio Precision System One model 322 or equal.

\*\*\*Power supply is 18-24VAC @ 500mA with the balanced line transformer option.

(SPECIFICATIONS SUBJECT TO CHANGE WITHOUT NOTICE)

## FBX-901 SIMPLIFIED INTERNAL BLOCK DIAGRAM

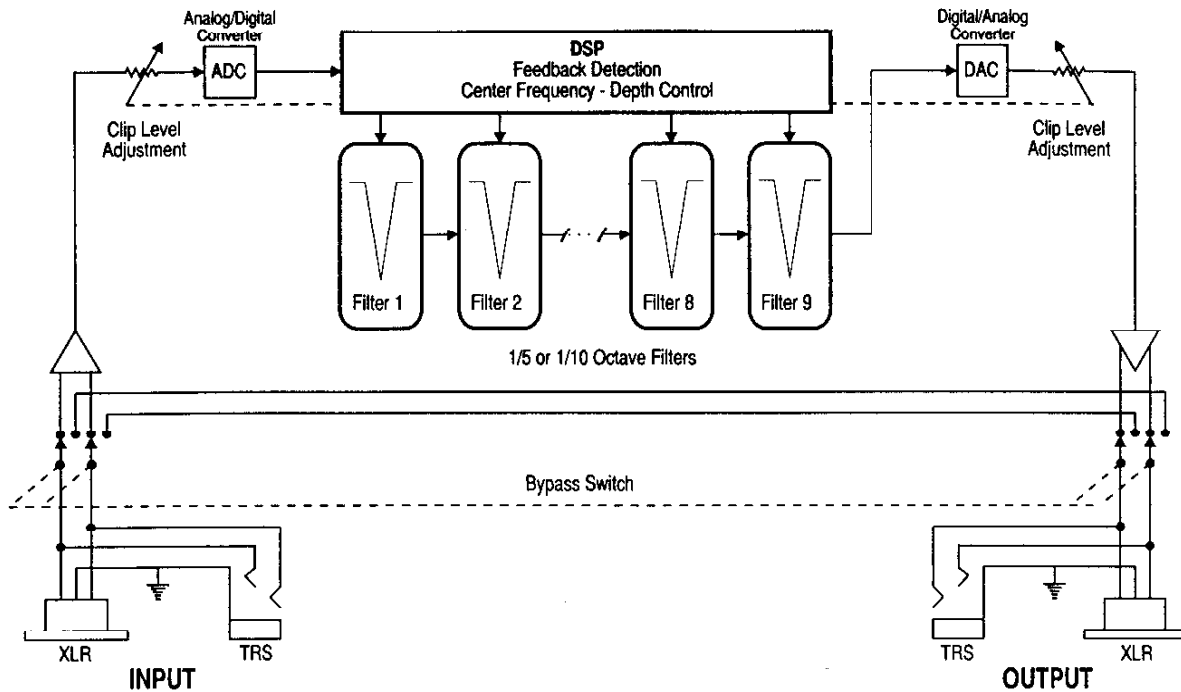

### FCC STATEMENT:

**NOTE:** This equipment has been tested and found to comply with the limits for a Class B digital device, pursuant to Part 15 of the FCC Rules. These limits are designed to provide reasonable protection against harmful interference in a residential installation. This equipment generates, uses, and can radiate radio frequency energy and, if not installed and used in accordance with the instructions, may cause harmful interference to radio communications. However, there is no guarantee that interference will not occur in a particular installation. If this equipment does cause harmful interference to radio or television reception, which can be determined by turning the equipment off and on, the user is encouraged to try to correct the interference by one or more of the following measures:

- Reorient or relocate the receiving antenna.
- Increase the separation between the equipment and receiver.
- Connect the equipment into an outlet on a circuit different from that to which the receiver is connected.
- Consult the dealer or an experienced radio TV technician for help.

Shielded cables must be used with this unit to ensure compliance with the Class B FCC limits.

**Warning:** Changes or modifications to this unit not expressly approved by the party responsible for compliance could void the user's authority to operate the equipment.

This digital apparatus does not exceed the Class B limits for radio noise emissions from digital apparatus set out in the Radio Interference Regulations of the Canadian Department of Communications.

Le présent appareil numérique n'émet pas de bruits radioélectriques dépassant les limites applicables aux appareils numériques de la class B prescrites dans le Règlement sur le brouillage radioélectrique édicté par le ministre des Communications du Canada.

### JAPANESE EMI COMPLIANCE STATEMENT:

この装置は、第二種情報装置（住宅地域又はその隣接した地域において使用されるべき情報装置）で住宅地域での電波障害防止を目的とした情報処理装置等電波障害自主規制協議会（VCCI）基準に適合しております。

しかし、本装置をラジオ、テレビジョン受信機に近接してご使用になると、受信障害の原因となることがあります。

取扱説明書に従って正しい取り扱いをして下さい。

This equipment is in the 2nd Class Category (information equipment to be used in a residential area or an adjacent area thereto) and conforms to the standards set by the Voluntary Control Council For Interference by Data Processing Equipment and Electronic Office Machines aimed at preventing radio interference in such residential area.

When used near a radio or TV receiver, it may become the cause of radio interference.

Read the instructions for correct handling.

## CAUTION

EXPOSURE TO EXTREMELY HIGH NOISE LEVELS MAY CAUSE A PERMANENT HEARING LOSS. INDIVIDUALS VARY CONSIDERABLY IN SUSCEPTIBILITY TO NOISE INDUCED HEARING LOSS, BUT NEARLY EVERYONE WILL LOSE SOME HEARING IF EXPOSED TO SUFFICIENTLY INTENSE NOISE FOR A SUFFICIENT TIME. THE U.S. GOVERNMENT'S OCCUPATIONAL SAFETY AND HEALTH ADMINISTRATION (OSHA) HAS SPECIFIED THE FOLLOWING PERMISSIBLE NOISE LEVEL EXPOSURES:

DURATION/DAY IN HOURS	SOUND LEVEL IN dBA, SLOW RESPONSE
8	90
6	92
4	95
3	97
2	100
1-1/2	102
1	105
1/2	110
1/4 or less	115

ACCORDING TO OSHA, ANY EXPOSURE IN EXCESS OF THE ABOVE PERMISSIBLE LIMITS COULD RESULT IN HEARING LOSS. EAR PLUGS OR PROTECTORS IN THE EAR CANALS OR OVER THE EARS MUST BE WORN WHEN OPERATING THIS DEVICE IN ORDER TO PREVENT A PERMANENT HEARING LOSS. IF EXPOSURE IS IN EXCESS OF THE LIMITS AS SET FORTH ABOVE, TO ENSURE AGAINST POTENTIALLY DANGEROUS EXPOSURE TO HIGH SOUND PRESSURE LEVELS, IT IS RECOMMENDED THAT ALL PERSONS EXPOSED TO EQUIPMENT CAPABLE OF PRODUCING HIGH SOUND PRESSURE LEVELS SUCH AS THIS DEVICE BE PROTECTED BY HEARING PROTECTORS WHILE THIS UNIT IS IN OPERATION.

1. Read all safety and operating instructions before using this product.
2. All safety and operating instructions should be retained for future reference.
3. Obey all cautions in the operating instructions and on the unit.
4. All operating instructions should be followed.
5. This product should not be used near water, i.e. a bathtub, sink, swimming pool, wet basement, etc.
6. This product should be located so that its position does not interfere with its proper ventilation. It should not be placed flat against a wall or placed in a built-in enclosure that will impede the flow of cooling air.
7. This product should not be placed near a source of heat such as a stove or radiator.
8. Connect only to a power supply of the type marked on the unit adjacent to the power.
9. Never break off the ground pin on the power supply cord.
10. Power supply cords should always be handled carefully. Never walk or place equipment on power supply cords. Periodically check cords for cuts or signs of stress, especially at the plug and the point where the cord exits the unit.
11. The power supply cord should be unplugged when the unit is to be unused for long periods of time.
12. Care should be taken so that objects do not fall and liquids are not spilled into the unit through the ventilation holes or any other openings.
13. This unit should be checked by a qualified service technician if:
  - A. The power supply cord or plug has been damaged.
  - B. Anything has fallen or been spilled into the unit.
  - C. The unit does not operate correctly.
  - D. The unit has been dropped or the enclosure damaged.
14. The user should not attempt to service this equipment. All service work should be done by a qualified service technician.

### One-Year Limited Warranty

**THIS LIMITED WARRANTY VALID ONLY WHEN PURCHASED AND REGISTERED IN THE UNITED STATES OR CANADA. ALL EXPORTED PRODUCTS ARE SUBJECT TO WARRANTY AND SERVICES TO BE SPECIFIED AND PROVIDED BY THE AUTHORIZED DISTRIBUTOR FOR EACH COUNTRY.**

Ces clauses de garantie ne sont valables qu'aux Etats-Unis et au Canada. Dans tous les autres pays, les clauses de garantie et de maintenance sont fixées par le distributeur national et assurées par lui selon la législation en vigueur.

Diese Garantie ist nur in den USA und Kanada gültig. Alle Export-Produkte sind der Garantie und dem Service des Importeurs des jeweiligen Landes unterworfen.

Esta garantía es válida solamente cuando el producto es comprado en E.U. continentales o en Canada. Todos los productos que sean comprados en el extranjero, están sujetos a las garantías y servicio que cada distribuidor autorizado determine y ofrezca en los diferentes países.

#### ONE-YEAR LIMITED WARRANTY/REMEDY

SABINE, INC. ("SABINE") warrants this product to be free from defects in material and workmanship for a period of one (1) year from date of purchase PROVIDED, however, that this limited warranty is extended only to the original retail purchaser and is subject to the conditions, exclusions and limitations hereinafter set forth:

#### CONDITIONS, EXCLUSIONS AND LIMITATIONS OF LIMITED WARRANTIES

These limited warranties shall be void and of no effect if:

- a. The first purchase of the product is for the purpose of resale; or
- b. The original retail purchase is not made from an AUTHORIZED SABINE DEALER; or
- c. The product has been damaged by accident or unreasonable use, neglect, improper service or maintenance, or other causes not arising out of defects in material or workmanship; or
- d. The serial number affixed to the product is altered, defaced or removed; or
- e. The power supply grounding pin is removed or otherwise defeated. In the event of a defect in material and/or workmanship covered by this limited warranty, Sabine will repair the defect in material or workmanship or replace the product, at Sabine's option; and provided, however, that, in any case, all costs of shipping, if necessary, are paid by you, the purchaser.

THE WARRANTY REGISTRATION CARD SHOULD BE ACCURATELY COMPLETED, MAILED TO AND RECEIVED BY SABINE WITHIN FOURTEEN (14) DAYS FROM THE DATE OF YOUR PURCHASE.

In order to obtain service under these warranties, you must:

- a. Bring the defective item to any AUTHORIZED SABINE DEALER and present therewith the ORIGINAL PROOF OF PURCHASE supplied to you by the AUTHORIZED SABINE DEALER in connection with your purchase from him of this product. If the DEALER is unable to provide the necessary warranty service, you will be directed to the nearest other SABINE AUTHORIZED DEALER which can provide such service.

OR

- b. Ship the defective item, prepaid, to:  
SABINE, INC.  
13301 HIGHWAY 441  
ALACHUA, FL 32615-8544

including therewith a complete, detailed description of the problem, together with a legible copy of the original PROOF OF PURCHASE and a complete return address. Upon Sabine's receipt of these items:

If the defect is remedial under the limited warranties and the other terms and conditions expressed have been complied with, Sabine will provide the necessary warranty service to repair or replace the product and will return it, FREIGHT COLLECT, to you, the purchaser. Sabine's liability to the purchaser for damages from any cause whatsoever and regardless of the form of action, including negligence, is limited to the actual damages up to the greater of \$500.00 or an amount equal to the purchase price of the product that caused the damage or that is the subject of or is directly related to the cause of action. Such purchase price will be

that in effect for the specific product when the cause of action arose. This limitation of liability will not apply to claims for personal injury or damage to real property or tangible personal property allegedly caused by Sabine's negligence. Sabine does not assume liability for personal injury or property damage arising out of or caused by a non-Sabine alteration or attachment, nor does Sabine assume any responsibility for damage to interconnected non-Sabine equipment that may result from the normal functioning and maintenance of the Sabine equipment.

UNDER NO CIRCUMSTANCES WILL SABINE BE LIABLE FOR ANY LOST PROFITS, LOST SAVINGS, ANY INCIDENTAL DAMAGES OR ANY CONSEQUENTIAL DAMAGES ARISING OUT OF THE USE OR INABILITY TO USE THE PRODUCT, EVEN IF SABINE HAS BEEN ADVISED OF THE POSSIBILITY OF SUCH DAMAGES.

THESE LIMITED WARRANTIES ARE IN LIEU OF ANY AND ALL WARRANTIES, EXPRESS OR IMPLIED, INCLUDING BUT NOT LIMITED TO, THE IMPLIED WARRANTIES OF MERCHANTABILITY AND FITNESS FOR A PARTICULAR USE; PROVIDED, HOWEVER, THAT IF THE OTHER TERMS AND CONDITIONS NECESSARY TO THE EXISTENCE OF THE EXPRESS LIMITED WARRANTIES, AS HEREIN ABOVE STATED, HAVE BEEN COMPLIED WITH, IMPLIED WARRANTIES ARE NOT DISCLAIMED DURING THE APPLICABLE ONE-YEAR PERIOD FROM DATE OF PURCHASE OF THIS PRODUCT.

SOME STATES DO NOT ALLOW LIMITATION ON HOW LONG AN IMPLIED WARRANTY LASTS, OR THE EXCLUSION OR LIMITATION OF INCIDENTAL OR CONSEQUENTIAL DAMAGES, SO THE ABOVE LIMITATIONS OR EXCLUSIONS MAY NOT APPLY TO YOU. THESE LIMITED WARRANTIES GIVE YOU SPECIFIC LEGAL RIGHTS, AND YOU MAY ALSO HAVE OTHER RIGHTS WHICH MAY VARY FROM STATE TO STATE.

THESE LIMITED WARRANTIES ARE THE ONLY EXPRESS WARRANTIES ON THIS PRODUCT, AND NO OTHER STATEMENT, REPRESENTATION, WARRANTY OR AGREEMENT BY ANY PERSON SHALL BE VALID OR BINDING UPON SABINE.

In the event of any modification or disclaimer of express or implied warranties, or any limitation of remedies, contained herein conflicts with applicable law, then such modification, disclaimer or limitation, as the case may be, shall be deemed to be modified to the extent necessary to comply with such law.

Your remedies for breach of these warranties are limited to those remedies provided herein, and Sabine gives this limited warranty only with respect to equipment purchased in the United States of America.

#### INSTRUCTIONS-WARRANTY REGISTRATION CARD

1. Mail the completed WARRANTY REGISTRATION CARD to:

SABINE, INC.  
13301 HIGHWAY 441  
ALACHUA, FL 32615-8544

- a. Keep the PROOF OF PURCHASE. In the event warranty service is required during the warranty period, you will need this document. There will be no identification card issued by Sabine, Inc.

#### 2. IMPORTANCE OF WARRANTY REGISTRATION CARDS AND NOTIFICATION OF CHANGES OF ADDRESS:

- a. Completion and mailing of WARRANTY REGISTRATION CARDS - Should notification become necessary for any condition that may require correction, the REGISTRATION CARD will help ensure that you are contacted and properly notified.
  - b. Notice of address changes - If you move from the address shown on the WARRANTY REGISTRATION CARD, you should notify Sabine of the change of address so as to facilitate your receipt of any bulletins or other forms of notification which may become necessary in connection with any condition that may require dissemination of information or correction.
3. You may contact Sabine directly by telephoning (904) 418-2000.
  4. Please have the Sabine product name and serial number available when communicating with Sabine Customer Service.

**SABINE**<sup>™</sup>  
ADAPTIVE AUDIO

MADE IN USA.

Manufactured by: Sabine, Inc. • 13301 Highway 441 • Alachua, FL 32615-8544 USA • Phone: (904)418-2000 • Fax: (904)418-2001

15X-901.009.5/1/90